

COMMERCE / Express, Inc.

Equipment Guide

Dry Van /

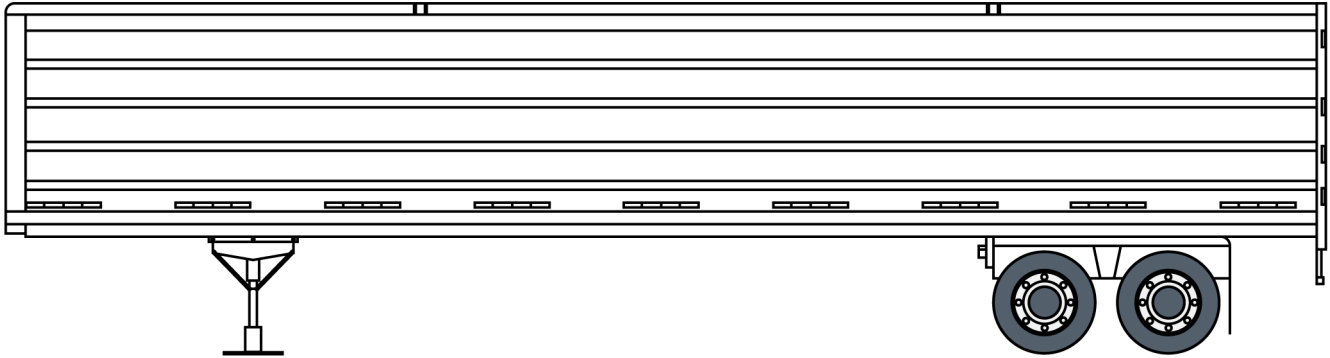

Standards	Capacity
Lengths: 28' - 53'	Max Weight (53'): 45,000 lbs
Widths: 96" - 102"	Max Pallets (53'): 26
Heights: 12.5' - 13.5'	Volume (53'): approx. 3,500'

Reefer Trailer /

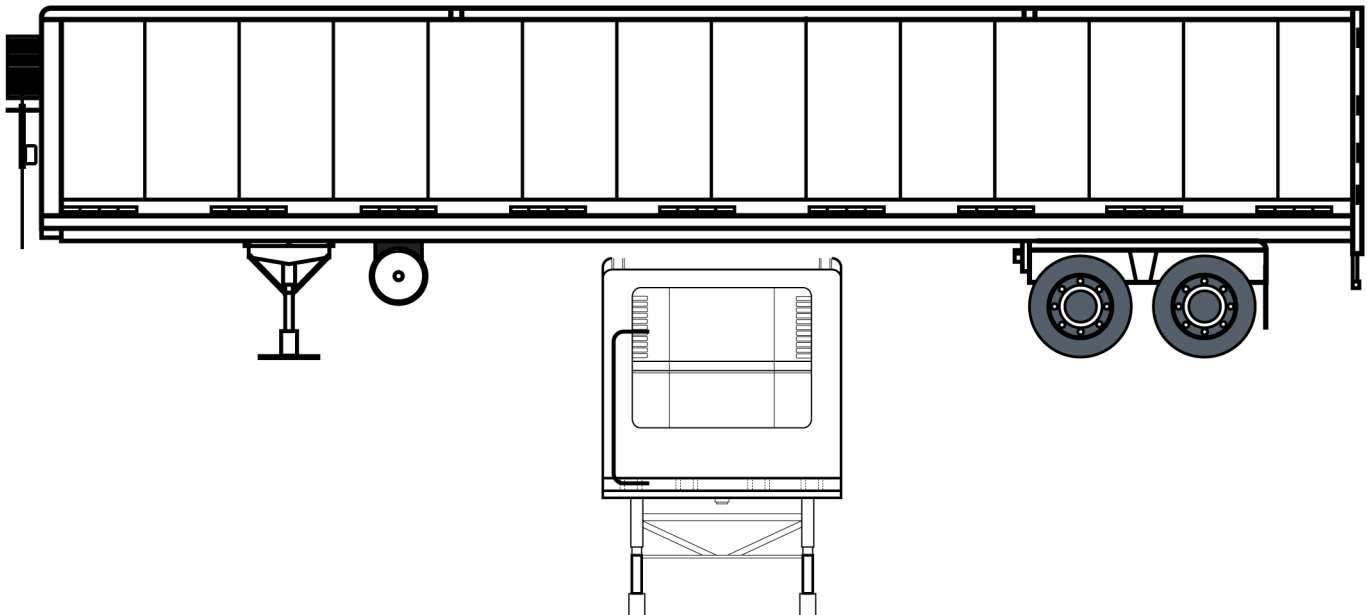

Standards	Capacity
Lengths: 28' - 53'	Max Weight (53'): 44,000 lbs
Widths: 96" - 102"	Max Pallets (53'): 26
Heights: 12.5' - 13.5'	Volume (53'): approx. 3,700'

Containers /

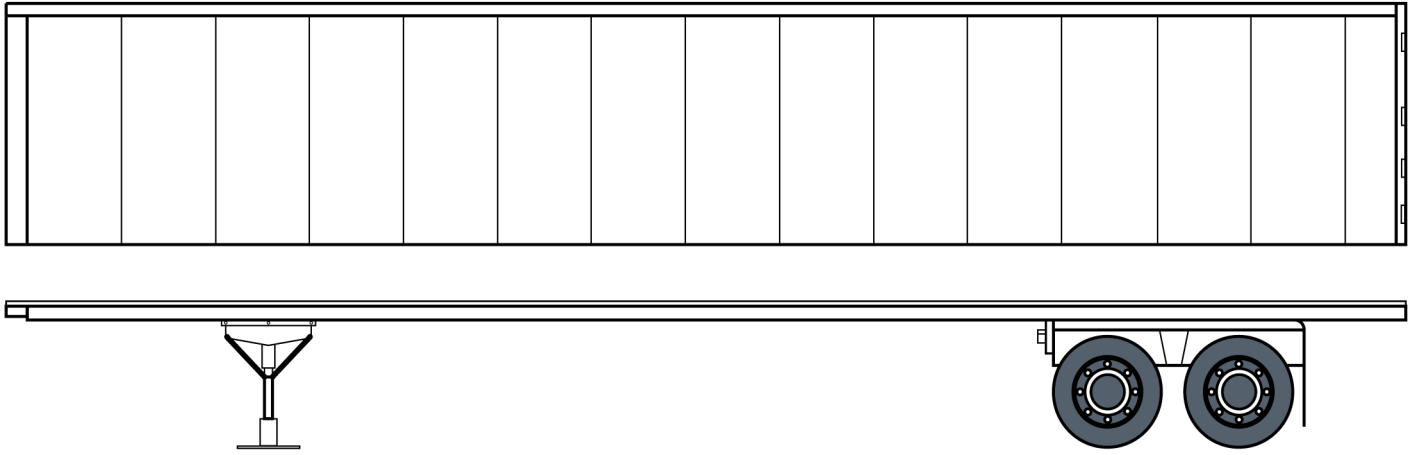

Standards
Lengths: 28' - 53'
Widths: 96" - 102"
Heights: 8' - 13.5'

Open Top /

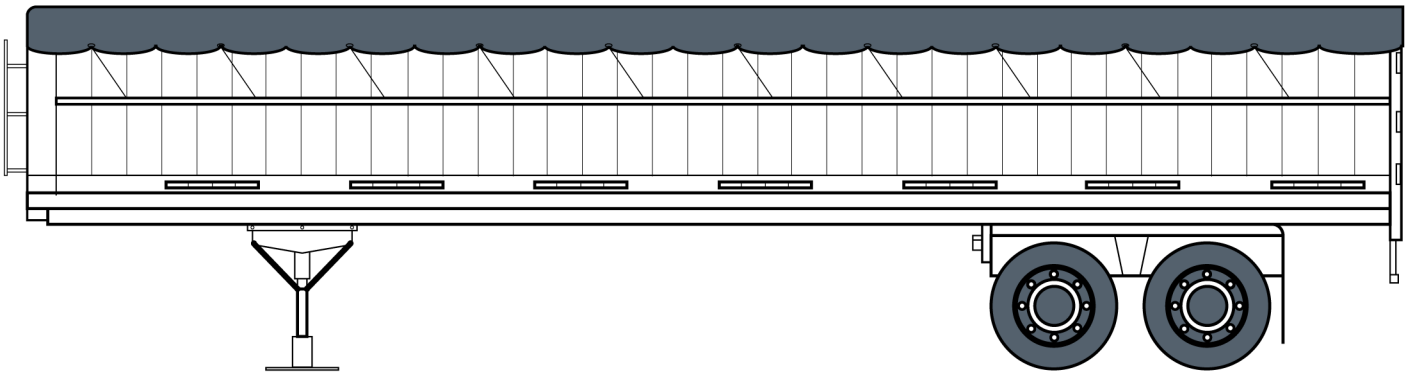

Standards	Capacity
Lengths: 28' - 53'	Max Weight (48'): 50,000 lbs
Widths: 96" - 102"	Max Volume (48'): 3,000
Heights: 8' - 13.5'	

Straight Truck (With Lift Gate) /

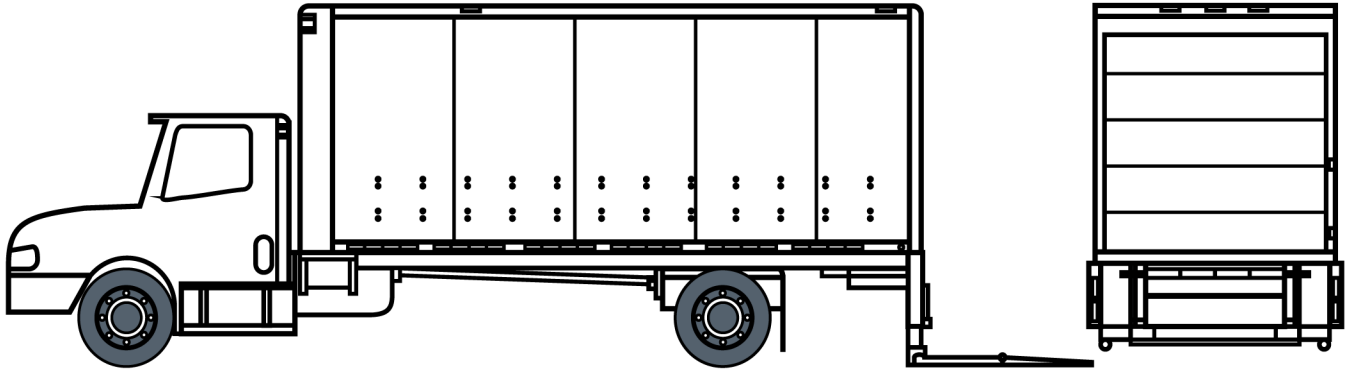

Standards	Capacity
Lengths: 22' - 26'	Max Weight (26'): 14,000 lbs
Widths: 96" - 102"	Max Pallets (26'): 12
Heights: 12.5' - 13.5'	Volume (26'): approx. 1,700'

LTL Pup Trailers /

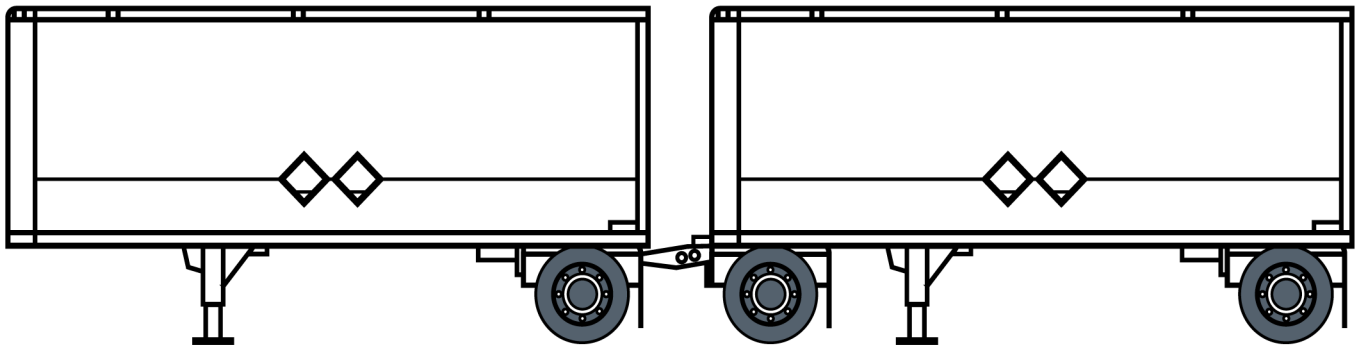

Standards	Capacity
Lengths: 28'	Max Weight (28'): 22,000 lbs
Widths: 96" - 102"	Max Pallets (28'): 14
Heights: 12.5' - 13.5'	Volume (28'): approx. 2,000'

Curtain Side /

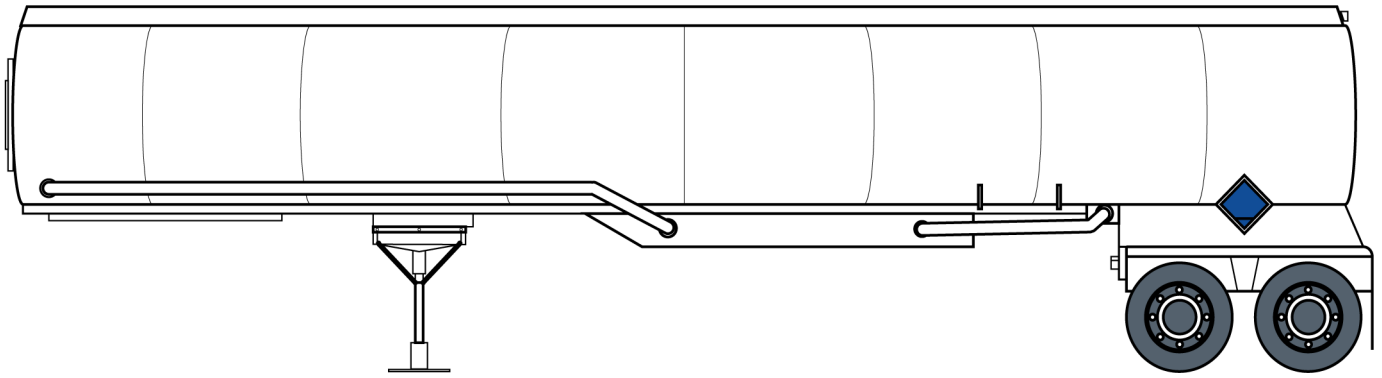

Standards	Capacity
Lengths: 45' - 53'	Max Weight (53'): 53,000 lbs
Widths: 102"	Max Pallets (53'): 26
Heights: 12.6' - 13.5'	Max Volume (53'): 3,800'

Tanker /

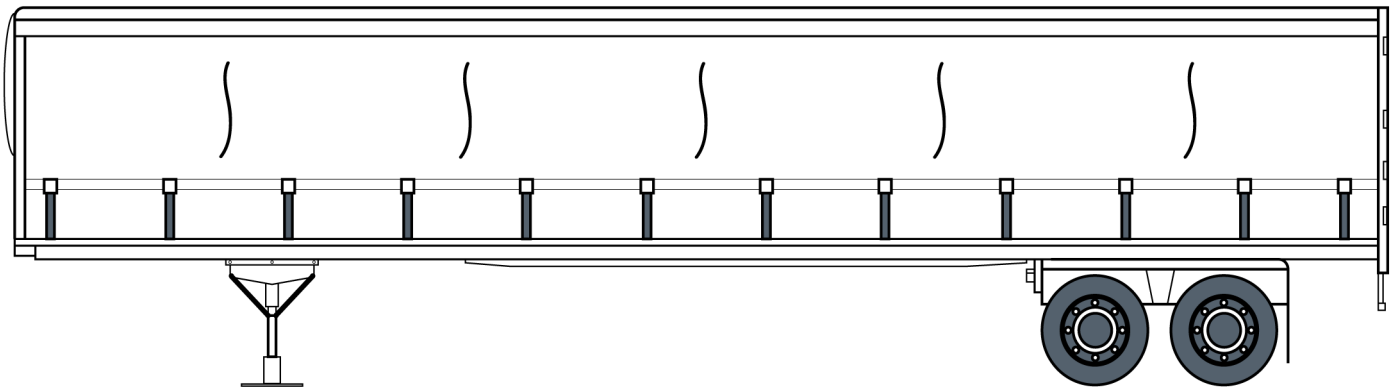

Standards	Capacity
Lengths: 40' - 53'	Max Volume (28'):
Widths: 96" - 102"	3,000 - 9,000 Gallons
Heights: 12' - 13.5'	
Bulkheads: 1 - 7	

Drop Deck /

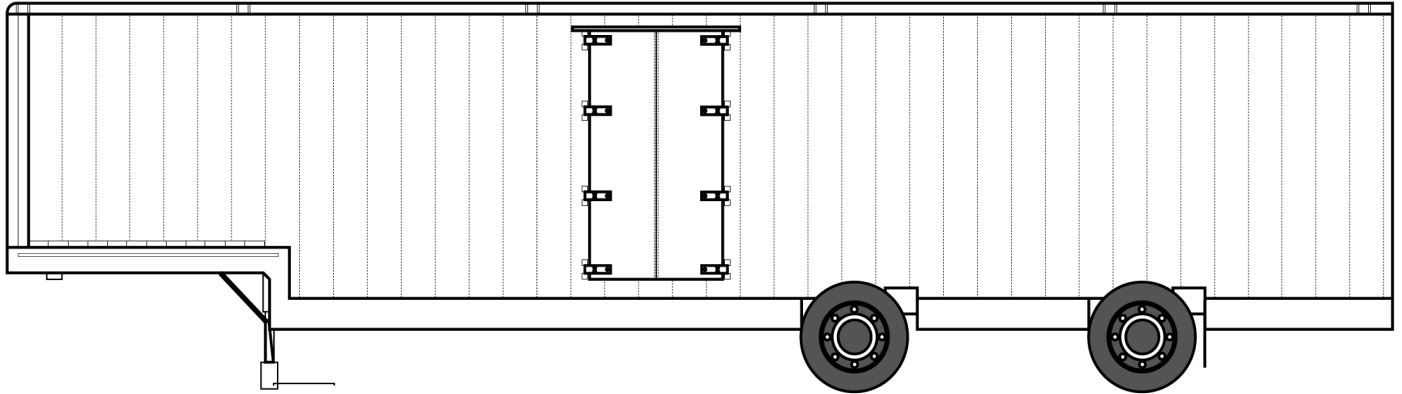

Standards	Capacity
Lengths: 45' - 53' Widths: 96" - 102" Heights: 13.5'	Max Volume (53'): 4,400

Hopper /

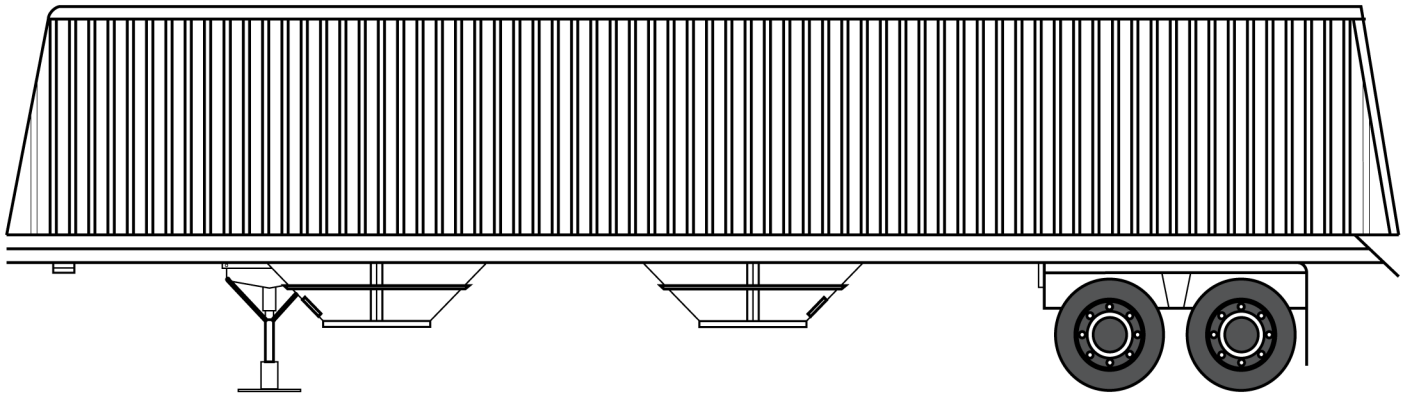

Standards	Capacity
Lengths: 40' - 53' Widths: 96" - 102" Heights: 10.5 - 13'	Max Volume (53'): 2,100'

Flatbed /

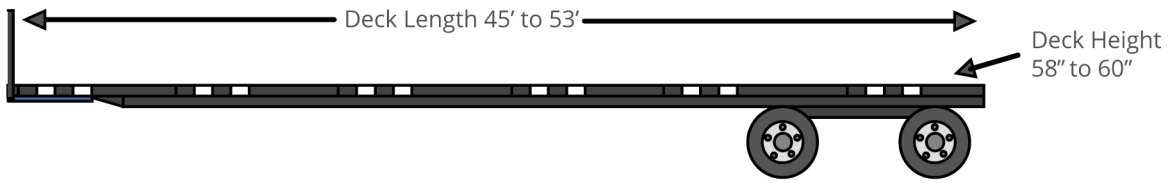

Acceptable Weights	Acceptable Dimensions
45K - 48K	Length: 45' - 53' Width: 8' 6" Height: up to 8' 6"

3 Axle Flatbed /

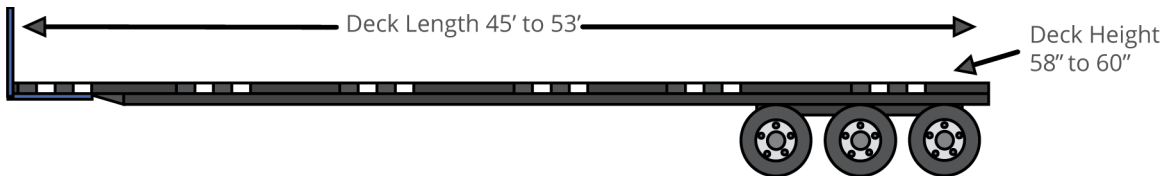

Acceptable Weights	Acceptable Dimensions
45K	Length: 45' - 53' Width: 8' 6" Height: up to 8' 6"

Extendable Flatbed /

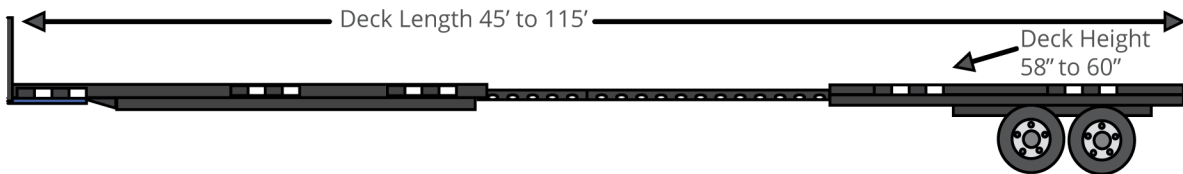

Acceptable Weights	Acceptable Dimensions
40K - 42K	Length: 45' - 115' Width: 8' 6" Height: up to 8' 6"

3 Axle Extendable Flatbed /

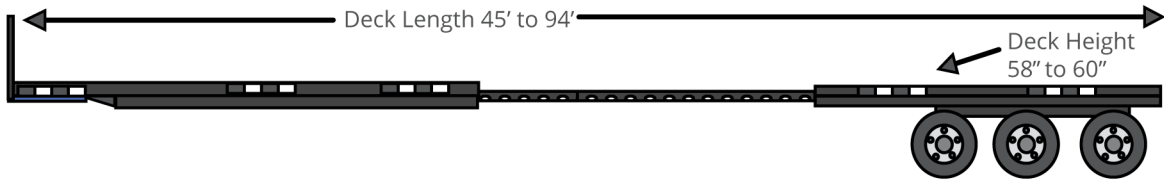

Acceptable Weights	Acceptable Dimensions
38K - 40K	Length: 45' - 94' Width: 8' 6" Height: up to 8' 6"

Stepdeck /

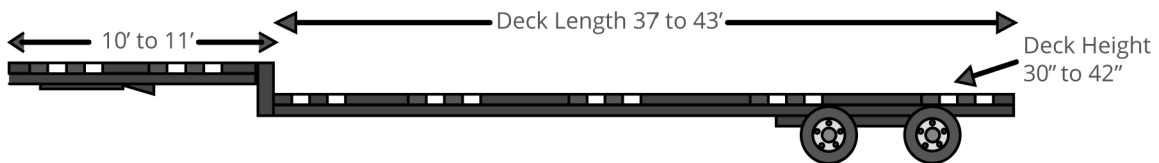

Acceptable Weights	Acceptable Dimensions
43K - 46K	Length: 37' - 43' Width: 8' 6" Height: up to 8' 6"

3 Axle Stepdeck /

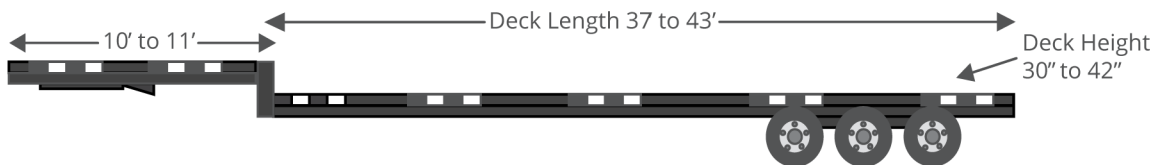

Acceptable Weights	Acceptable Dimensions
40K - 43K	Length: 37' - 43' Width: 8' 6" Height: up to 8' 6"

Extendable Stepdeck /

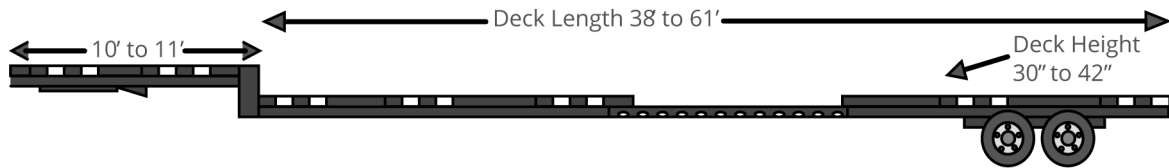

Acceptable Weights	Acceptable Dimensions
42K - 44K	Length: 38' - 61' Width: 8' 6" Height: up to 8' 6"

3 Axle Extendable Stepdeck /

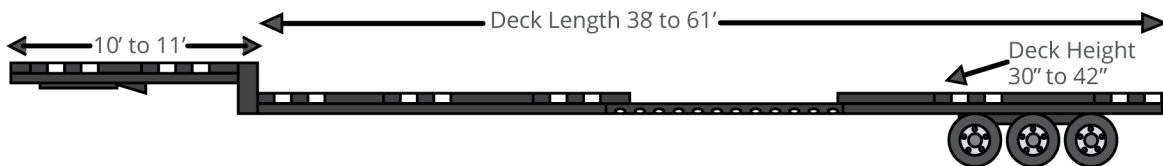

Acceptable Weights	Acceptable Dimensions
38K - 41K	Length: 38' - 68' Width: 8' 6" Height: up to 10' 6"

Double Drop / Detach /

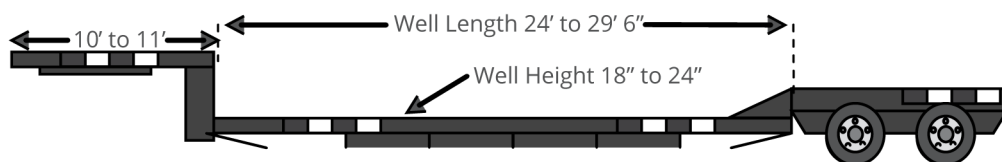

Acceptable Weights	Acceptable Dimensions
38K - 42K	Length: 24' - 29' 6" Width: 8' 6" Height: up to 12'

Double Drop / Detach /

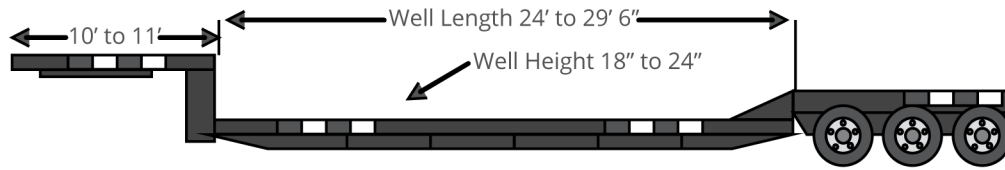

Acceptable Weights	Acceptable Dimensions
37K - 40K	Length: 24' - 29' 6" Width: 8' 6" Height: up to 12'

Lowboy / R.G.N /

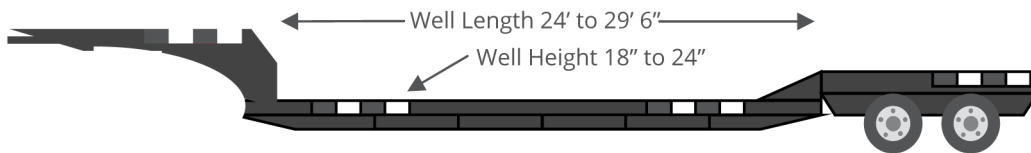

Acceptable Weights	Acceptable Dimensions
38K - 42K	Length: 24' - 29' 6" Width: 8' 6" Height: up to 12'

3 Axle Lowboy / R.G.N /

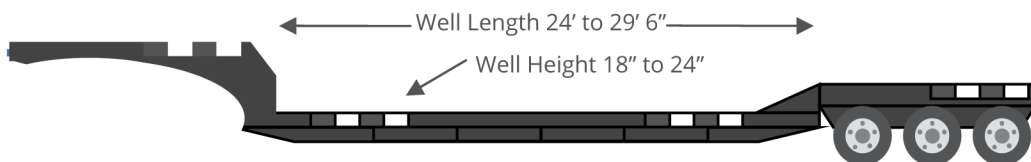

Acceptable Weights	Acceptable Dimensions
37K - 40K	Length: 24' - 29' 6" Width: 8' 6" Height: up to 12'

Extendable Double Drop / Detach /

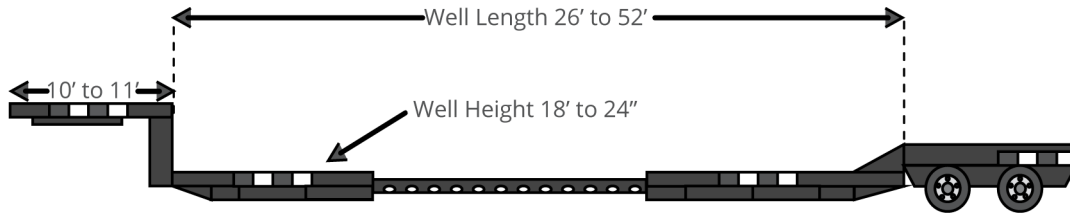

Acceptable Weights	Acceptable Dimensions
37K - 40K	Length: 26' - 52' Width: 8' 6" Height: up to 12'

3 Axle Extendable Double Drop / Detach /

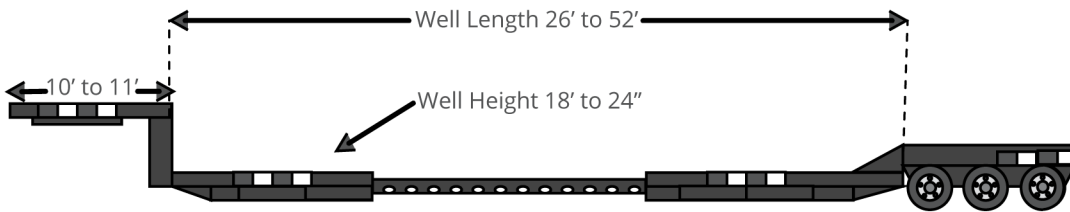

Acceptable Weights	Acceptable Dimensions
34K - 37K	Length: 26' - 52' Width: 8' 6" Height: up to 12'

Quad Axle Double Drop / Detach /

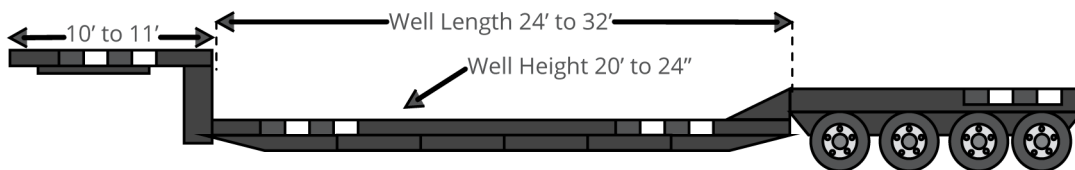

Acceptable Dimensions
Length: 26' - 32' Weight: up to 120K

Quad Axle Lowboy / R.G.N. /

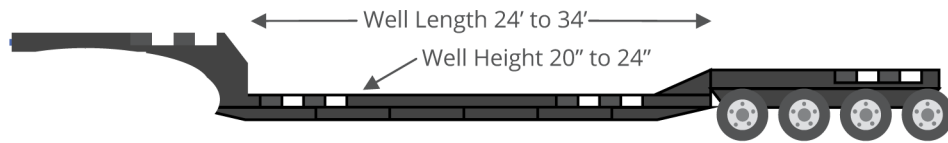

Acceptable Dimensions

Length: 24' - 34'
Weight: up to 120K

Quad Axle Extendable Double Drop / Detach /

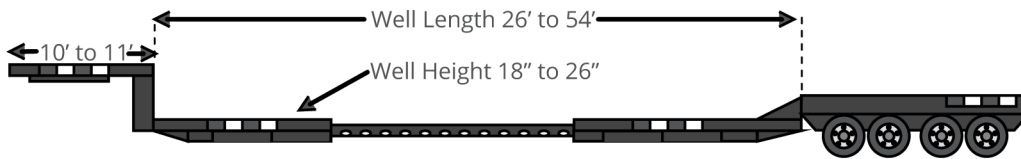

Acceptable Dimensions

Length: 26' - 54'
Weight: up to 110K

Multi-Axle Lowboy Combination /

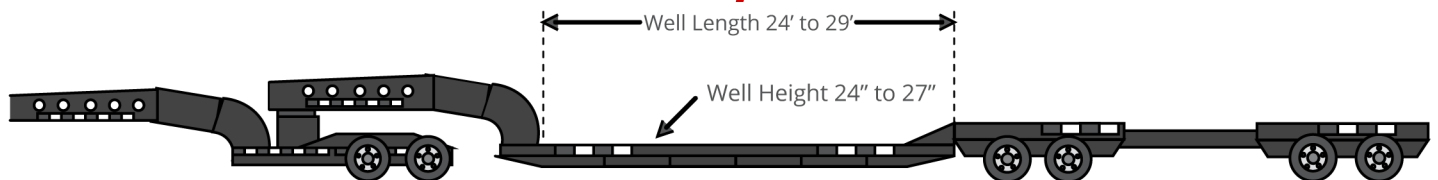

Acceptable Dimensions

Length: 24' - 29'
Weight: up to 150K

Multi-Axle Lowboy Combination /

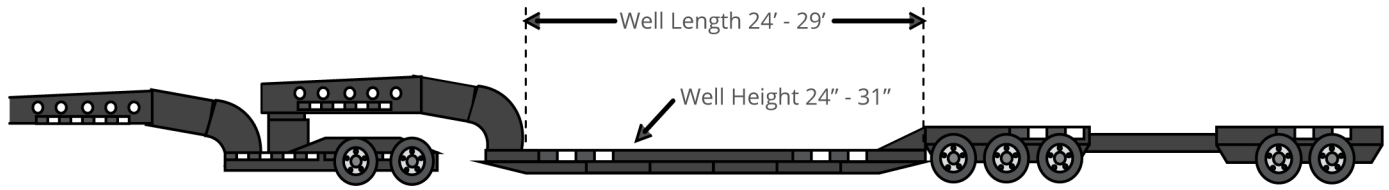

Acceptable Dimensions

Length: 24' - 29'
Weight: up to 150K

Quad Axle Extendable Double Drop / Detach /

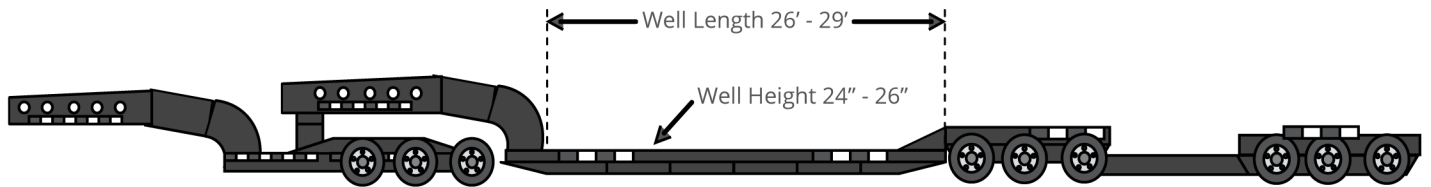

Acceptable Dimensions

Length: 26' - 29'
Weight: up to 160K

Multi-Axle Lowboy Combination /



Acceptable Dimensions

Length: 24' - 51'
Weight: up to 150K

Multi-Axle Lowboy Combination /



Acceptable Dimensions

Length: 26' - 55'
Weight: up to 150K

Multi-Axle Lowboy Combination /



Acceptable Dimensions

Length: 26' - 87'
Weight: up to 160K